

## ALTA PRESSIONE

### Sfere orientabili

Doppio orientamento

Corpo in acetale  
Bocchettone in inox

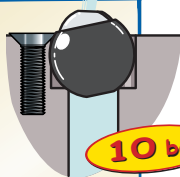

10 bar

Ø sfera	Ø getto	Ref.
12 mm	4 mm	BE0107
14 mm	4 mm	BE0108
15 mm	4 mm	BE0109
1/2" mm	4 mm	BE0111
15 mm	8/32 unc	BE0240

### Sfere orientabili

a getto regolabile

Corpo in acetale  
Bocchettone in inox

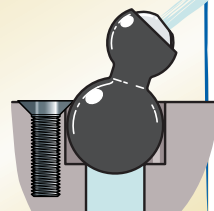

10 bar

Ø sfera	Ø sfera	Ref.
12 mm	2,8 mm	BU2305
14 mm	4 mm	BU2320
15 mm	2,8 mm	BU2325
15 mm	4 mm	BU2330

Per torni CNC  
e per centri con  
pompa ad alta  
pressione



Up to  
100 bar

### Sfere orientabili

per fori lisci  
senza fissaggio

Corpo in acetale  
Bocchettone in inox

Ø foro di maschiatura della  
montaggio sfera



10 bar

Ø foro di maschiatura della montaggio sfera	Ref.
10 mm M 4 x .7	SB9510
12 mm M 5 x .8	SB9520
14 mm M 6 x 1.0	SB9530
15 mm M 6 x 1.0	SB9540

### Tubi di estensione

in ottone  
maschiatura  
della sfera



lunghezza

Ref.

lunghezza	Ref.
M 4 x .7 35 mm	SB9710
M 5 x .8 40 mm	SB9720
M 6 x 1.0 50 mm	SB9730

### Sfere con tubo

Sfera orientabile  
posizionamento del tubo

Tubo in rame ricotto  
lunghezza 152mm



33 bar

Ø sfera	Ø getto	Ref.
14 mm	4,5 mm	LP5512
15 mm	3 mm	LP5514
15 mm	4,5 mm	LP5516
12,5 mm	3 mm	LP5530
12,5 mm	4,5 mm	LP5532
15,8 mm	4,5 mm	LP5536

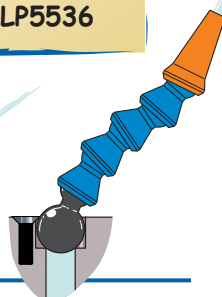
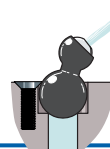
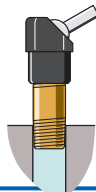

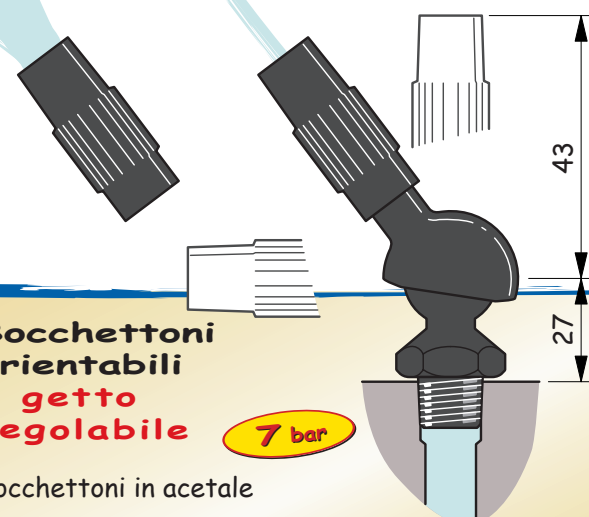

**Bocchettoni orientabili a getto regolabile** **7 bar**

Bocchettoni in acetale

Filettatura	Inclinazione/ Rotazione	Ref.
1/4	90° / 360°	MJ0117
1/8 NPT/BSPT		MJ3010

**Bocchettoni filettati**  
NPT / BSPT

**Alta Pressione**

**100 bar**

Corpo in ottone, sfera e tubo in inox  
Con tubo orientabile

Filettatura	Ø - lung	Ref.
1/8	1 x 6,35 mm	PM4010
1/8	2,2 x 6,35 mm	PM6010
1/8	3 x 6,35 mm	PM4038
1/8	3 x 32 mm	PM4042



**Bocchettoni regolabili**  
per fori filettati **10 Bar**

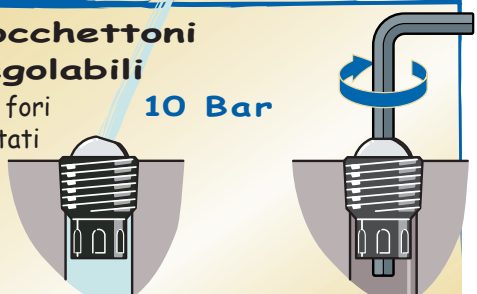

Filettatura	Ø getto	Ref.
1/8	4 mm	PJ0510
1/4	4 mm	PJ0530



**Bocchettoni a sfera**  
NPT / BSPT

Filettatura	Ø getto	Ref.
1/8	2,8 mm	TJ0100
1/4	4 mm	TJ0101
3/8	5,6 mm	TJ0102

Ø - lung	Ref.
1/8 2,8 x 6,35 mm	TJ0130
1/8 4 x 12,7 mm	TJ0136
1/8 3,8 x 32 mm	TJ0138
1/4 4 x 12,7 mm	TJ0148
1/4 3,8 x 32 mm	TJ0150

Maschiatura	Ø getto	Ref.
1/8	2,8 mm	CJ7510
1/4	4 mm	CJ7530
3/8	5,6 mm	CJ7544

Ø - lung	Ref.
1/8 2,8 x 6,35 mm	CJ7512
1/8 4 x 12,7 mm	CJ7518
1/4 4 x 12,7 mm	CJ7532
1/4 3,8 x 32 mm	CJ7534

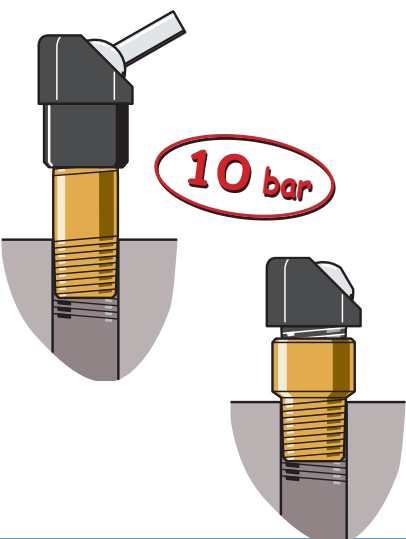

**Adattatori:**  
ottone NPT / BSPT per bocchettoni a sfera ref. TJ- e TC-

Filettatura	Lung	Ref.
1/8	20 mm	DF8705
1/4	22 mm	DF8710
3/8	25 mm	DF8715

**Adattatori lunghi**

Filettatura	Lung	Ref.
1/8	38 mm	DF8720
1/4	38 mm	DF8725
3/8	38 mm	DF8730

**Raccordi**

Filettatura/ Maschiatura	Lung	Ref.
1/8 - 1/8	20 mm	DF8745
1/4 - 1/4	24 mm	DF8750
3/8 - 3/8	26 mm	DF8755